

Filterline type FL with built-in fan:

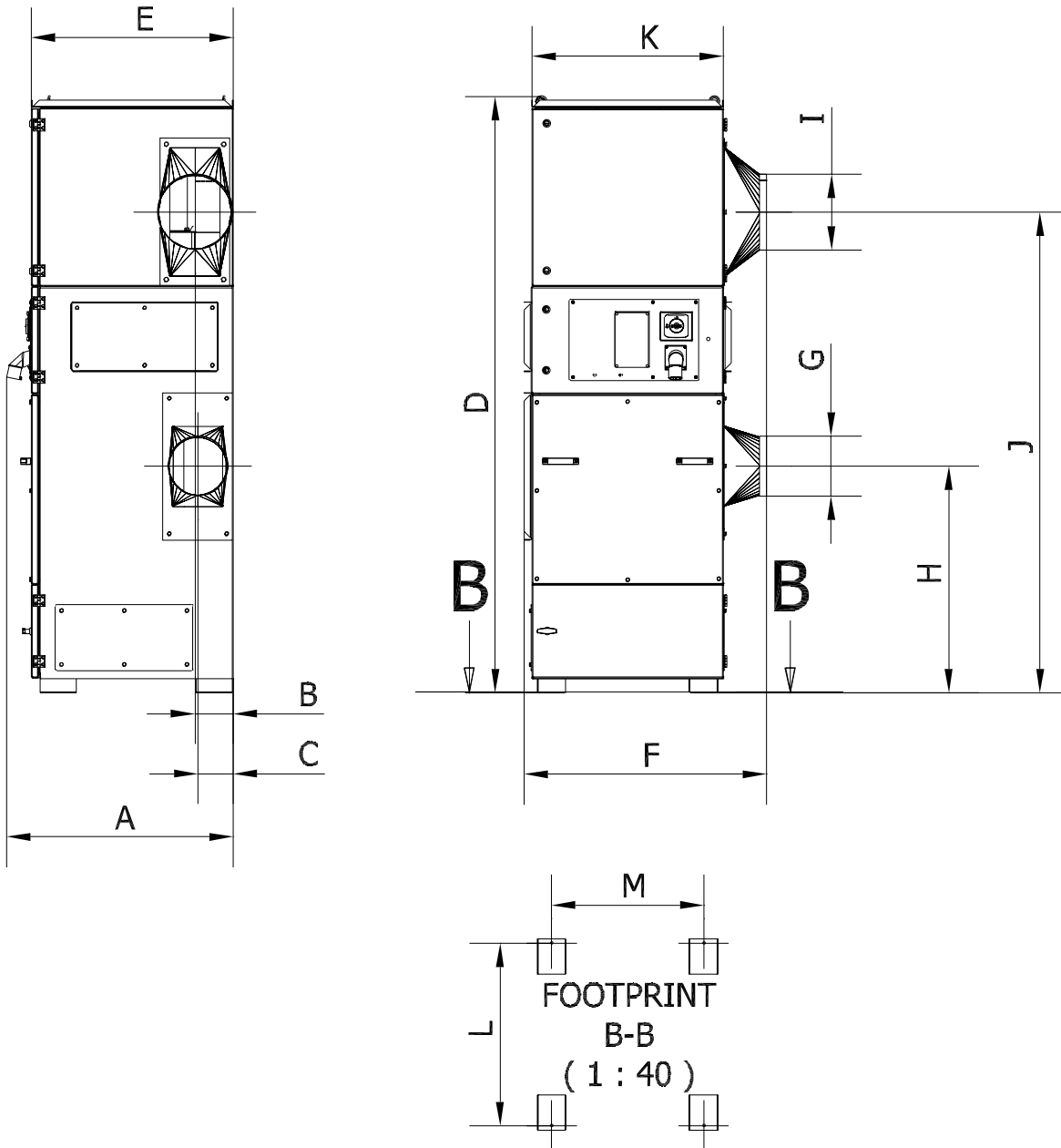

Type	Standard version Order no.	Prepared for operation with frequency convert Order no.	A	B	C	D	E	F	G	H	I	J	K	L	M
FL 26/VE 2200	04 618 000	04 618 150	945	159	147	2494	842	1014	∅250	948	∅315	2010	800	762	636
FL 26/VE 3000	04 619 000	04 619 150	945	159	147	2494	842	1014	∅250	948	∅315	2010	800	762	636
FL 52/VE 4000	04 620 000	04 620 150	1197	147	145	2489	1084	1012	∅315	948	∅315	2006	800	1004	620
FL 52/VE 5500	04 621 000	04 621 150	1197	147	145	2489	1084	1012	∅315	948	∅315	2006	800	1004	620
FL 52/RV 45	04 677 500	04 677 650	1201	147	145	2611	1085	1012	∅315	948	∅315	2130	800	1004	636
FL 104/VE 5500	04 622 000	04 622 150	1187	287	282	3270	1085	1195	∅500	1264	∅500	2787	800	1004	616
FL 104/VE 7500	04 623 000	04 623 150	1187	287	284	3270	1187	1195	∅500	1264	∅500	2787	800	1004	616
FL 104/RV 45	04 678 100	04 678 250	1190	287	282	3270	1085	1195	∅500	1264	∅500	2787	800	1004	616
FL 104/RV 50	04 678 000	04 678 150	1189	287	282	3270	1085	1195	∅500	1264	∅500	2787	800	1004	616

Rev. 12.16 Data is subject to alterations

Filterline type FL with built-in fan:

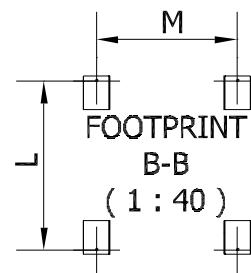
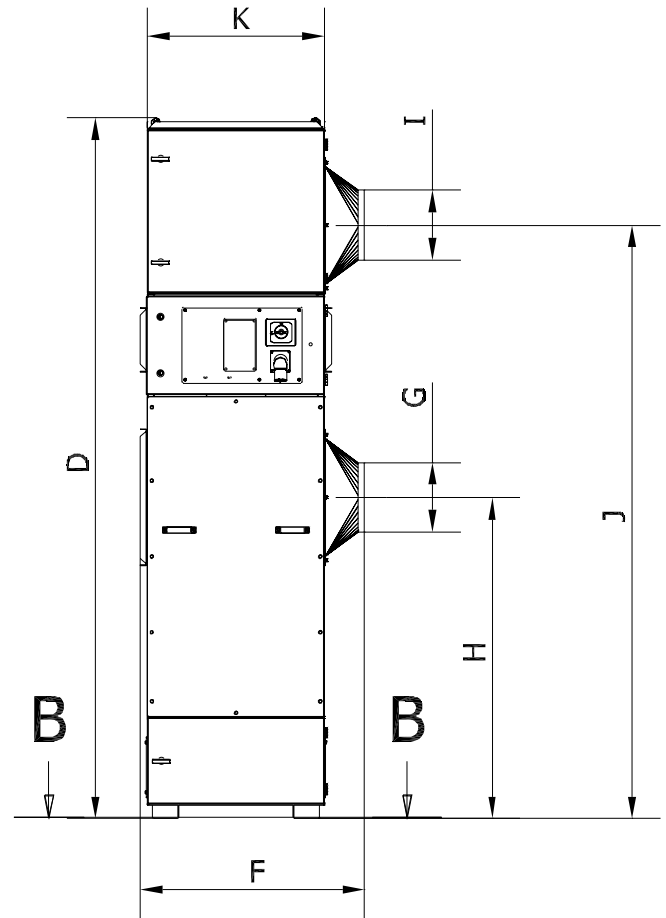
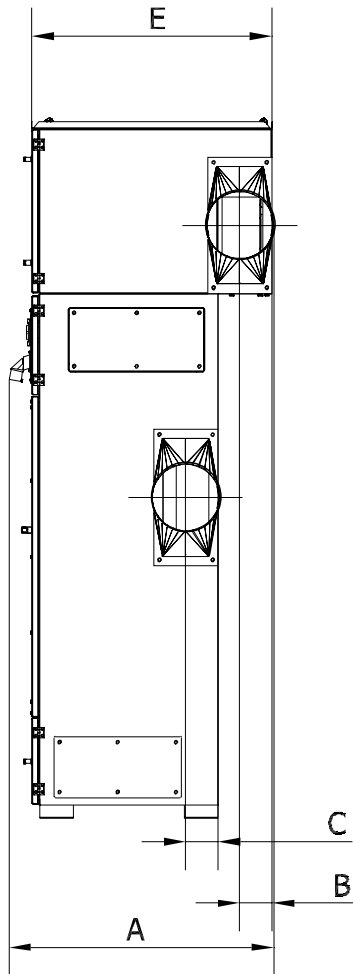

Type	Standard version Order no.	Prepared for operation with frequency convert Order no.	A	B	C	D	E	F	G	H	I	J	K	L	M
FL 26/RV 35/2	-	04 677 250	1199	145	147	2493	1084	1013	ø250	948	ø315	2010	800	762	636
FL 26/RV 35/3	04 677 000	04 677 150	1199	145	147	2493	1084	1013	ø250	948	ø315	2010	800	762	636
FL 52H/VE 4000	04 618 250	04 618 400	1194	145	147	3159	1082	1012	ø315	1488	ø315	2676	800	762	636
FL 52H/VE 5500	04 618 500	04 618 650	1194	145	147	3159	1084	1012	ø315	1448	ø315	2676	800	762	636
FL 52H/RV 45	04 678 050	04 678 200	1202	145	145	3279	1085	1013	ø315	1448	ø315	2798	800	762	636

Rev. 12.16 Data is subject to alterations

Filterline type FL 26 - 104 H without built-in fan:

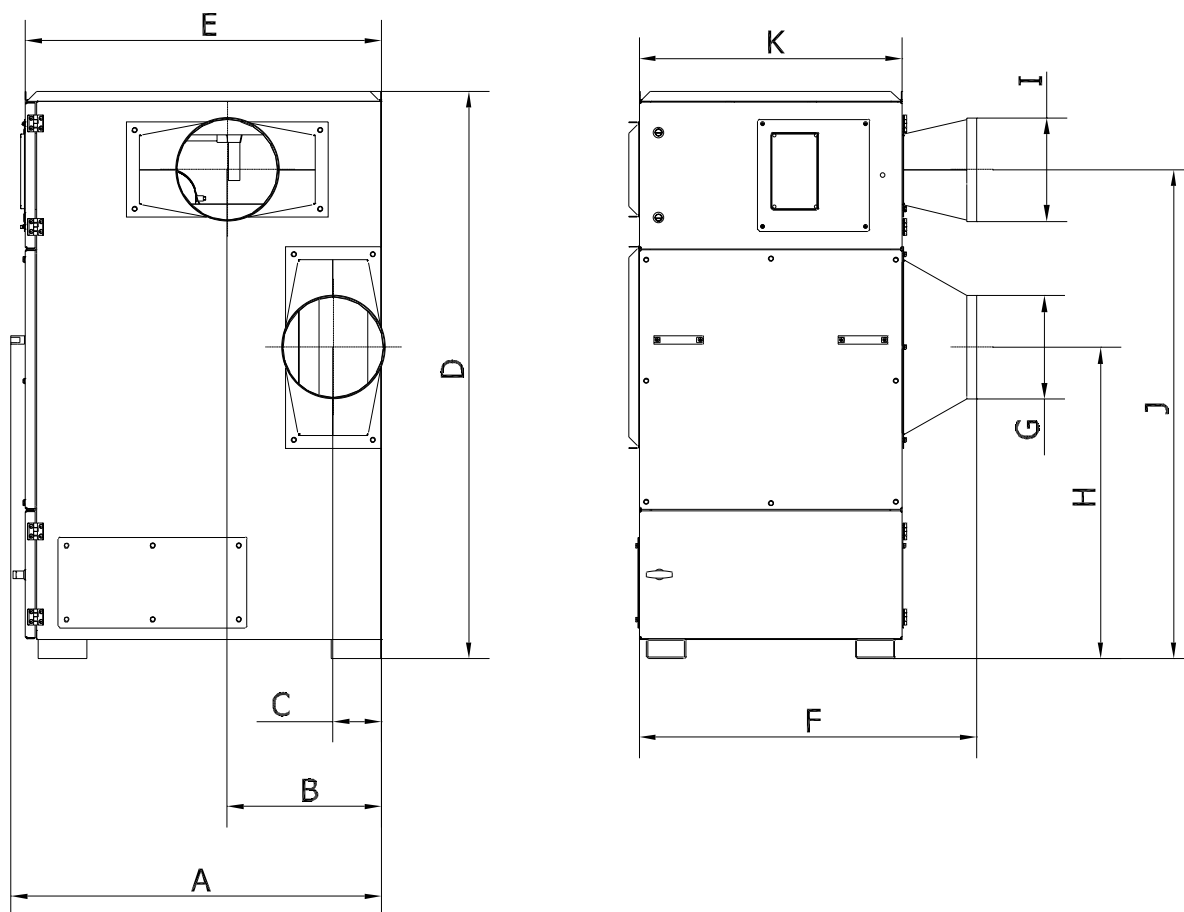

Type	Order no.	A	B	C	D	E	F	G	H	I	J	K
FL 26	04 627 000	884	369	147	1728	842	981	ø250	948	ø315	1489	800
FL 52H	04 627 250	845	367	145	2398	840	1012	ø315	1480	ø315	2159	800
FL 52	04 628 000	1128	469	147	1728	1084	1026	ø315	948	ø315	1489	800
FL 104	04 629 000	1128	482	292	2389	1084	1133	ø500	1263	ø500	1985	800